

RIGHT HAND SWING

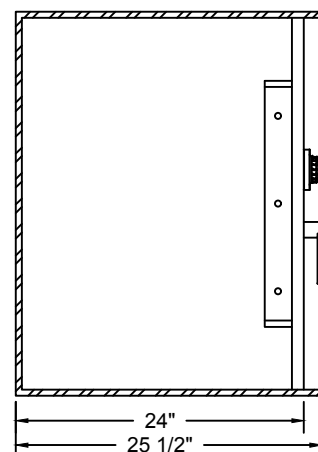

SECTION VIEW

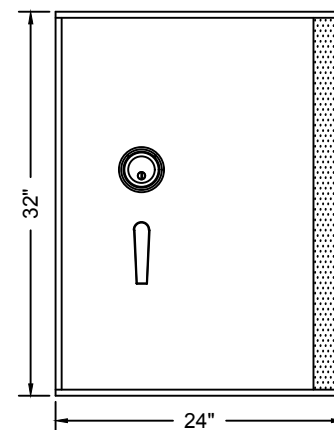

ELEVATION VIEW

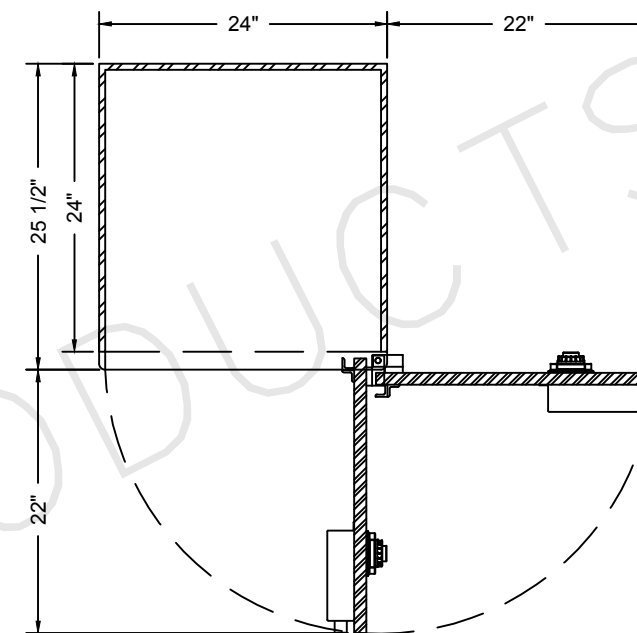

PLAN VIEW

LEFT HAND SWING

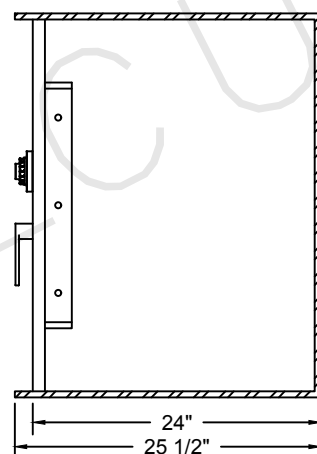

SECTION VIEW

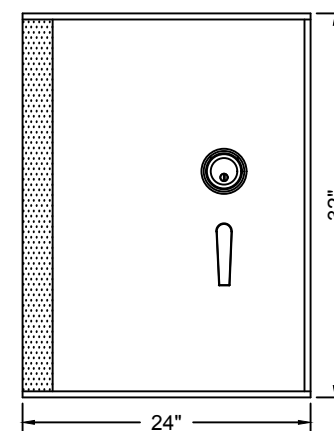

ELEVATION VIEW

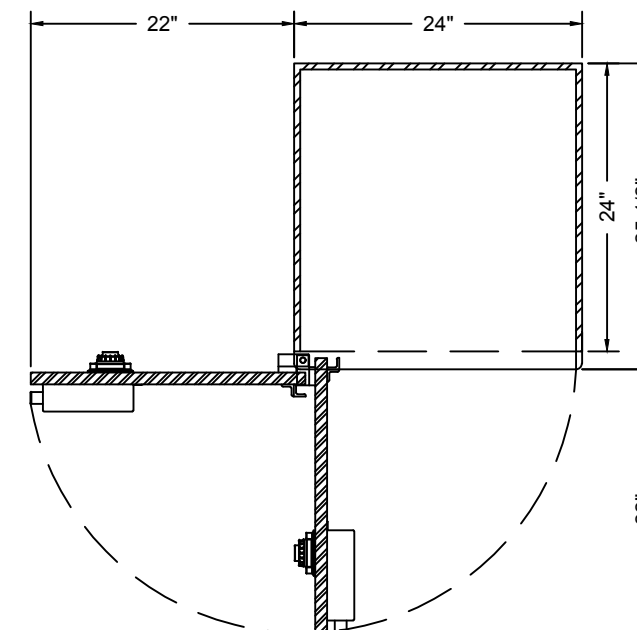

PLAN VIEW

NOTES

- SAFE INSTALLED WITH THE FOLLOWING:
- GROUP 2M COMBINATION LOCK WITH KEY LOCKING DIAL
 - HEAT SENSOR AND DOOR CONTACT
 - STAINLESS STEEL HINGE COVER
 - 3 POINT BOLT MECHANISM
 - EXTENDED ALARM WIRES

MADE IN AMERICA



DRAWING TITLE SAFE 322424		TOLERANCES		
CLIENT	DRAWN BY	DATE	DWG. NO. SAFE 322424	
PROJECT	APPROVED BY	DATE	SCALE 3/4" = 1' 0"	SHEET 1 OF 1